

Thermally-Enhanced High Power RF LDMOS FETs 45 W, 1930 – 1990 MHz

Description

The PTFA190451E and PTFA190451F are thermally-enhanced, 45-watt, internally matched LDMOS FETs designed for WCDMA, TD-SCDMA and other cellular standards in the 1930 to 1990 MHz frequency band. These devices are available in thermally-enhanced packages with eared or earless flanges. Manufactured with Infineon's advanced LDMOS process, these devices provide excellent thermal performance and superior reliability.

PTFA190451E
 Package H-36265-2

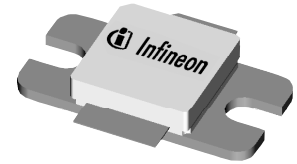

PTFA190451F
 Package H-37265-2

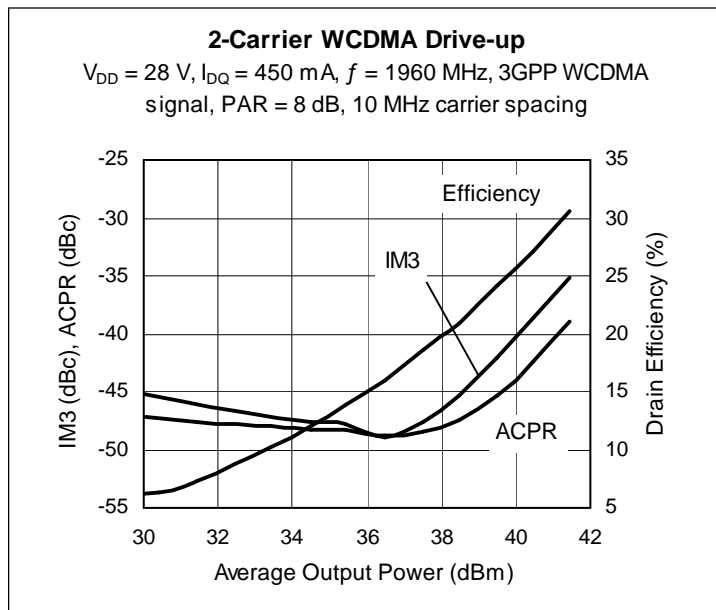

Features

- Broadband internal matching
- Typical two-carrier WCDMA performance at 1960 MHz, 28 V
 - Average output power = 11 W
 - Linear gain = 17.5 dB
 - Efficiency = 28.0%
 - Intermodulation distortion = -39 dBc
 - Adjacent channel power = -42 dBc
- Typical CW performance, 1960 MHz, 28 V
 - Output power at P-1dB = 60 W
 - Efficiency = 60%
- Integrated ESD protection: Human Body Model, Class 2 (minimum)
- Excellent thermal stability, low HCI drift
- Capable of handling 10:1 VSWR @ 28 V, 45 W (CW) output power
- Pb-free and RoHS compliant

RF Characteristics

WCDMA Measurements (tested in Infineon test fixture)

$V_{DD} = 28\text{ V}$, $I_{DQ} = 450\text{ mA}$, $P_{OUT} = 11\text{ W}$ average

$f_1 = 1955\text{ MHz}$, $f_2 = 1965\text{ MHz}$, 3GPP signal, channel bandwidth = 3.84 MHz, peak/average = 8 dB @ 0.01% CCDF

Characteristic	Symbol	Min	Typ	Max	Unit
Gain	G_{ps}	16.5	17.5	—	dB
Drain Efficiency	η_D	27	28	—	%
Intermodulation Distortion	IMD	—	-39	-37	dBc

All published data at $T_{CASE} = 25^\circ\text{C}$ unless otherwise indicated

ESD: Electrostatic discharge sensitive device—observe handling precautions!

RF Characteristics (cont.)

Two-tone Measurements (not subject to production test—verified by design/characterization in Infineon test fixture)

$V_{DD} = 28\text{ V}$, $I_{DQ} = 450\text{ mA}$, $P_{OUT} = 45\text{ W PEP}$, $f = 1990\text{ MHz}$, tone spacing = 1 MHz

Characteristic	Symbol	Min	Typ	Max	Unit
Gain	G_{ps}	—	17.5	—	dB
Drain Efficiency	η_D	—	38	—	%
Intermodulation Distortion	IMD	—	-31	—	dBc

DC Characteristics

Characteristic	Conditions	Symbol	Min	Typ	Max	Unit
Drain-Source Breakdown Voltage	$V_{GS} = 0\text{ V}$, $I_{DS} = 10\text{ mA}$	$V_{(BR)DSS}$	65	—	—	V
Drain Leakage Current	$V_{DS} = 28\text{ V}$, $V_{GS} = 0\text{ V}$	I_{DSS}	—	—	1.0	μA
	$V_{DS} = 63\text{ V}$, $V_{GS} = 0\text{ V}$	I_{DSS}	—	—	10.0	μA
On-State Resistance	$V_{GS} = 10\text{ V}$, $V_{DS} = 0.1\text{ V}$	$R_{DS(on)}$	—	0.91	—	Ω
Operating Gate Voltage	$V_{DS} = 28\text{ V}$, $I_{DQ} = 450\text{ mA}$	V_{GS}	2.0	2.5	3.0	V
Gate Leakage Current	$V_{GS} = 10\text{ V}$, $V_{DS} = 0\text{ V}$	I_{GSS}	—	—	1.0	μA

Maximum Ratings

Parameter	Symbol	Value	Unit
Drain-Source Voltage	V_{DSS}	65	V
Gate-Source Voltage	V_{GS}	-0.5 to +12	V
Junction Temperature	T_J	200	$^{\circ}\text{C}$
Total Device Dissipation	P_D	211	W
		Above 25 $^{\circ}\text{C}$ derate by	1.21
Storage Temperature Range	T_{STG}	-40 to +150	$^{\circ}\text{C}$
Thermal Resistance ($T_{CASE} = 70^{\circ}\text{C}$, 45 W CW)	$R_{\theta JC}$	0.83	$^{\circ}\text{C/W}$

Ordering Information

Type and Version	Package Outline	Package Description	Shipping	Marking
PTFA190451E V4	H-36265-2	Thermally-enhanced slotted flanges, single-ended	Tray	PTFA190451E
PTFA190451F V4	H-37265-2	Thermally-enhanced earless flange, single-ended	Tray	PTFA190451F

Typical Performance (data taken in a production test fixture)

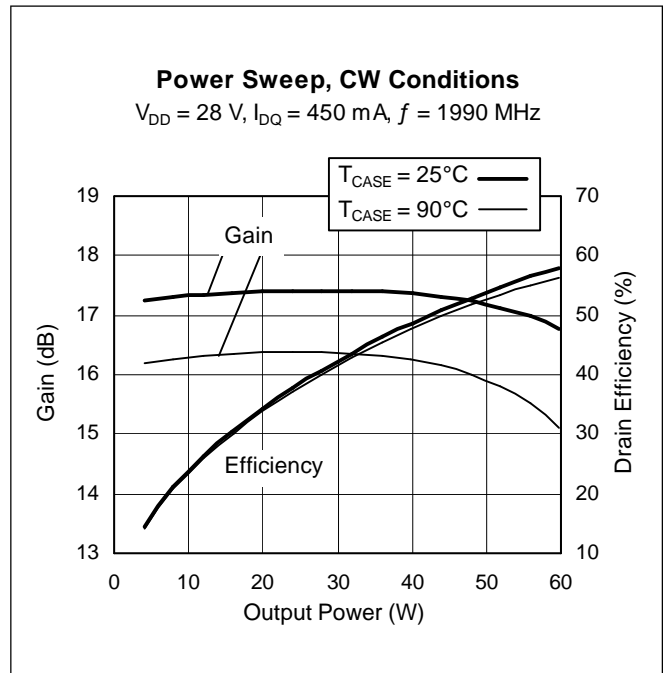
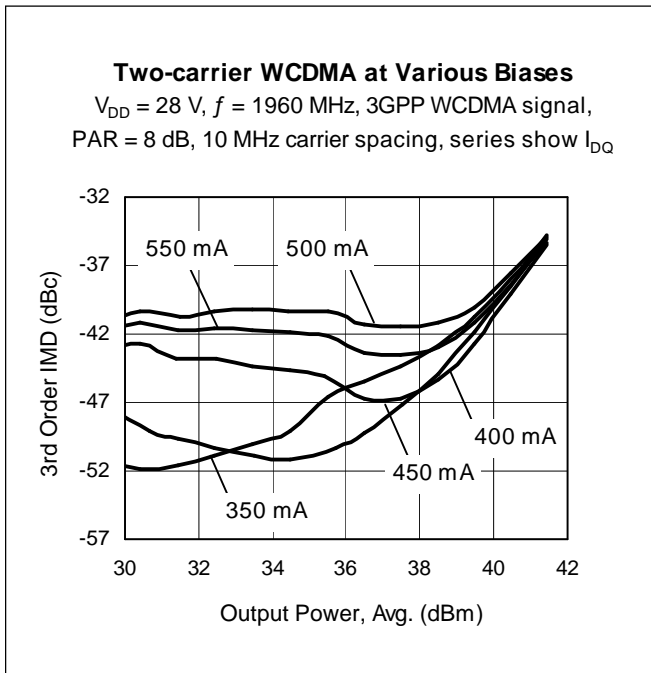
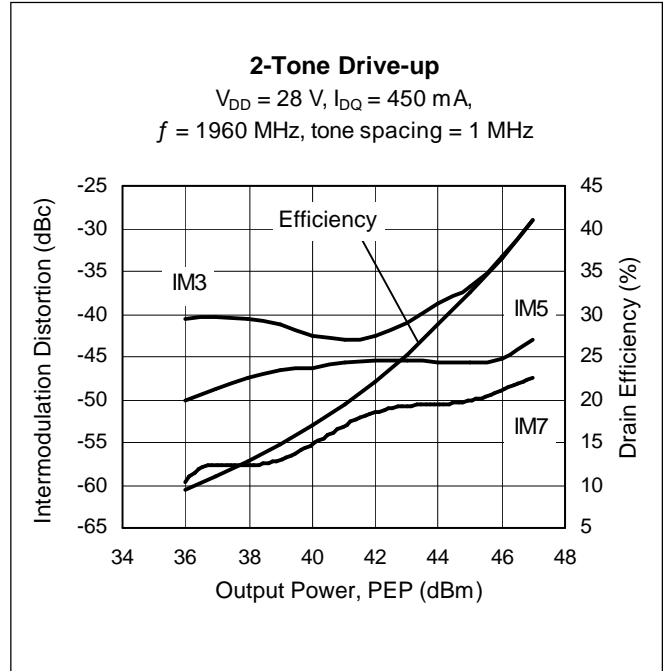
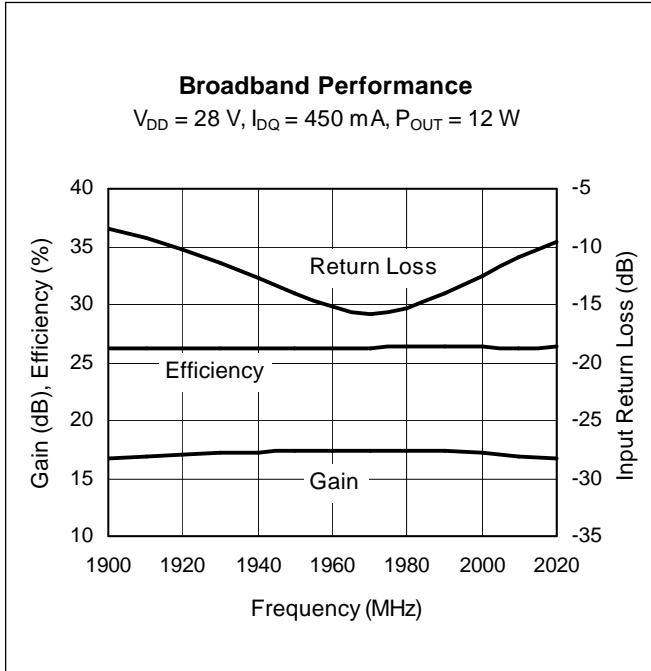

Typical Performance (cont.)

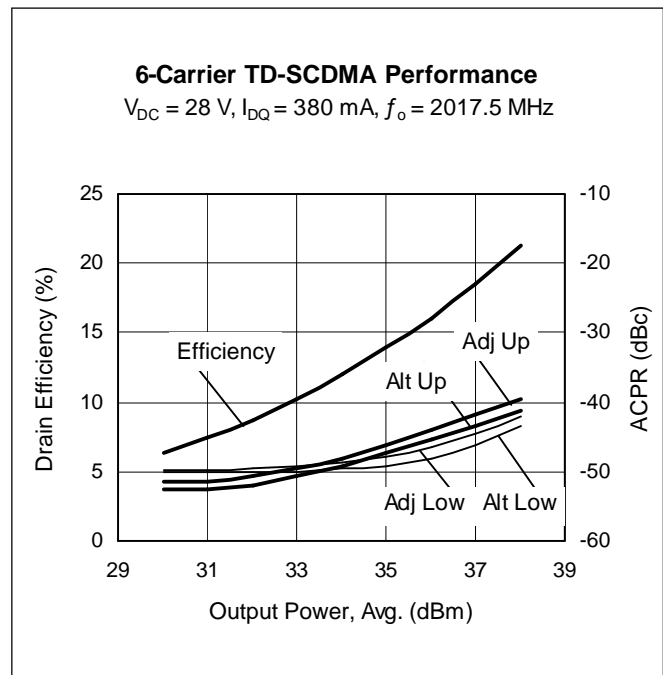
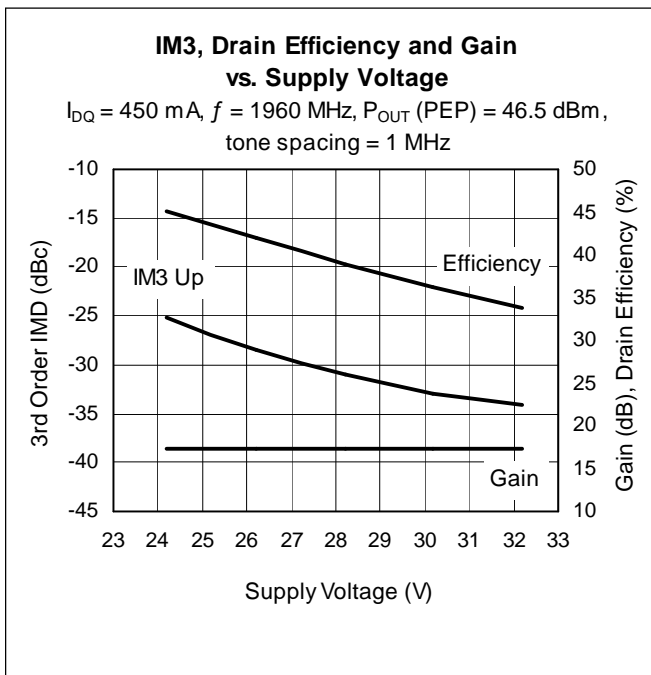
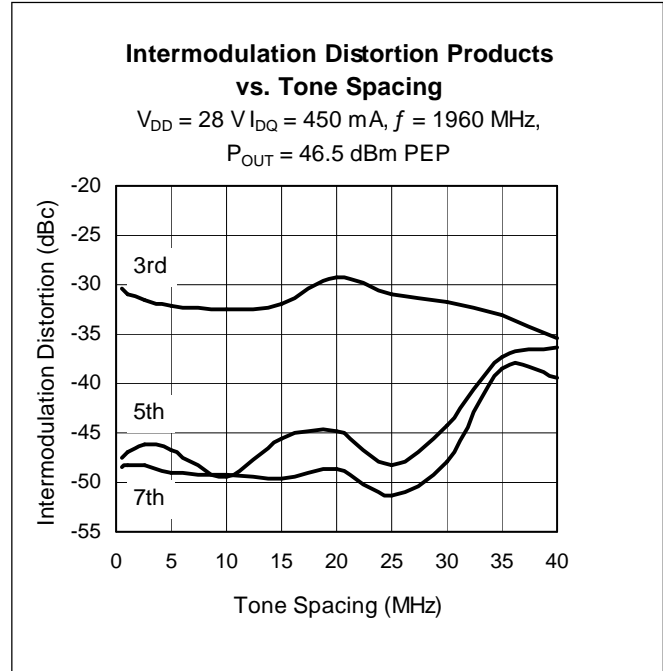
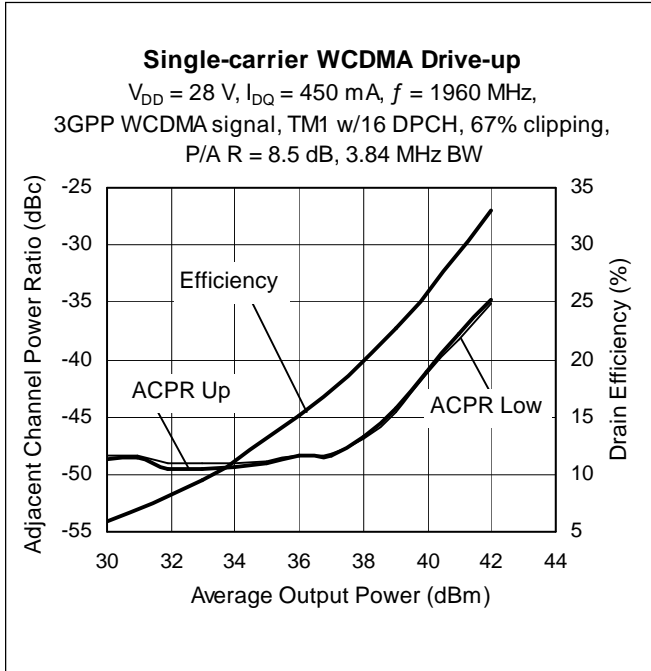

Typical Performance (cont.)

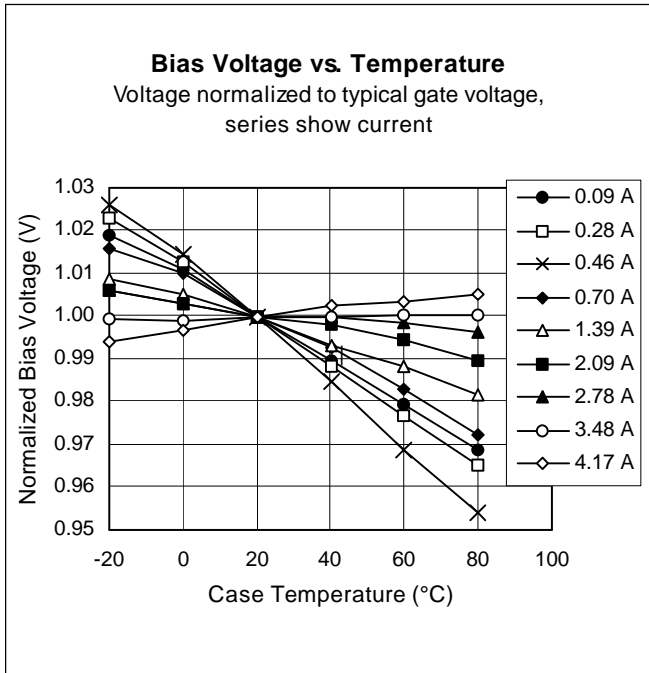

Broadband Circuit Impedance

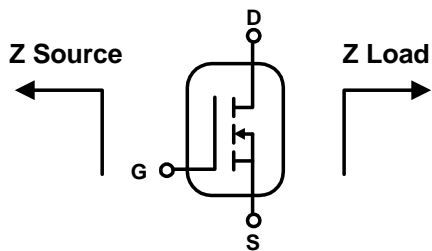

Frequency MHz	Z Source W		Z Load W	
	R	jX	R	jX
1900	15.51	-0.094	5.73	-1.71
1930	16.30	-0.444	5.68	-1.52
1960	17.19	-0.881	5.69	-1.31
1990	18.02	-1.437	5.63	-1.08
2020	18.79	-2.315	5.61	-0.91

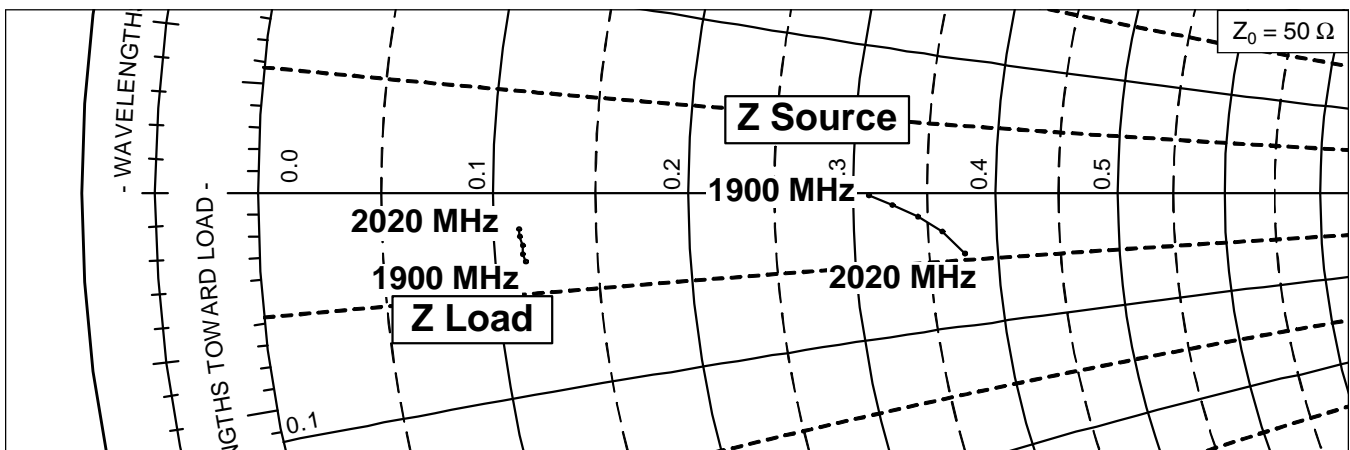

Reference Circuit

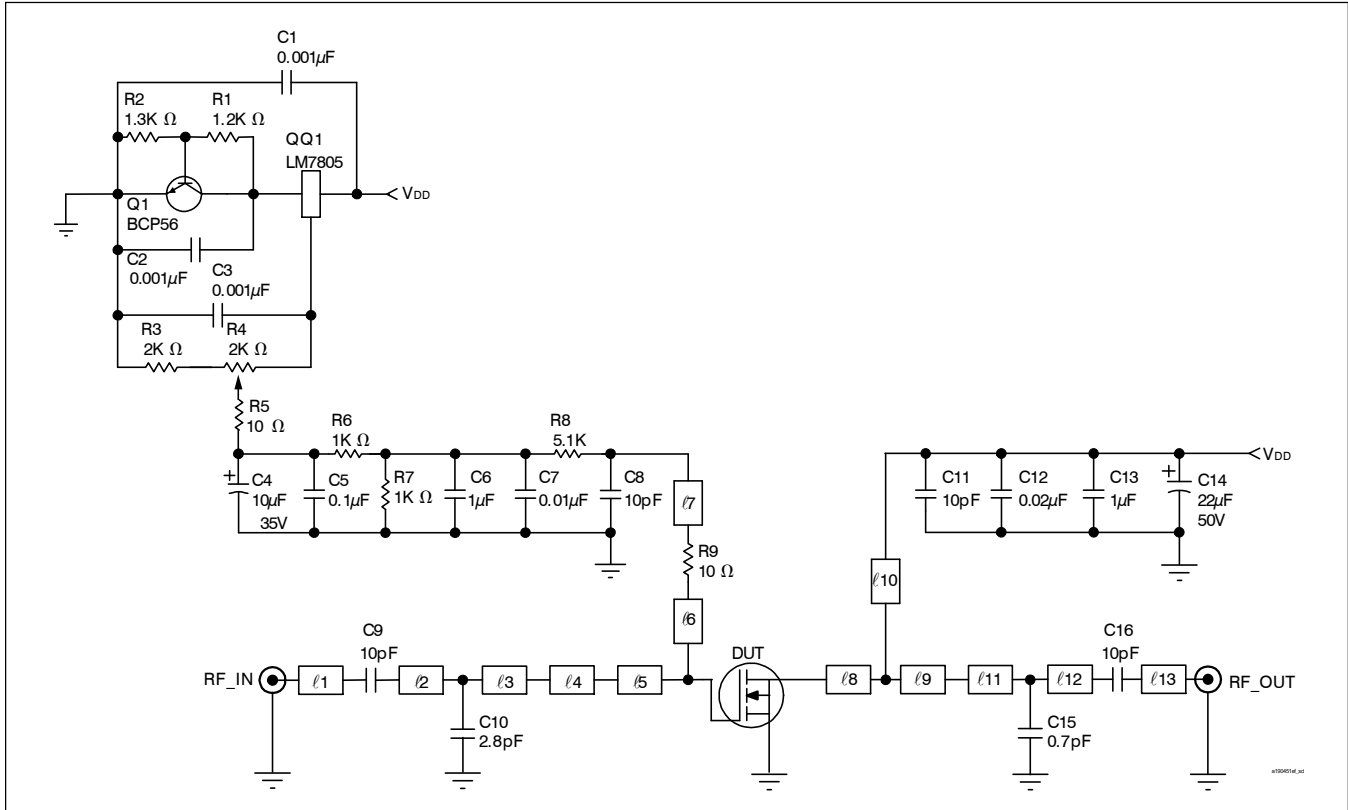

Reference circuit schematic for $f = 1960 \text{ MHz}$

Circuit Assembly Information

DUT	PTFA190451E or PTFA190451F	LDMOS Transistor	
PCB	0.76 mm [.030"] thick, $\epsilon_r = 3.48$	Rogers 4350	1 oz. copper

Microstrip	Electrical Characteristics at 1960 MHz ¹	Dimensions: L x W (mm)	Dimensions: L x W (in.)
l1	0.031 λ , 50.0 Ω	2.79 x 1.57	0.110 x 0.062
l2	0.089 λ , 50.0 Ω	8.26 x 1.57	0.325 x 0.062
l3	0.076 λ , 50.0 Ω	7.04 x 1.57	0.277 x 0.062
l4	0.045 λ , 6.7 Ω	3.84 x 21.08	0.151 x 0.830
l5	0.014 λ , 6.7 Ω	1.14 x 21.08	0.045 x 0.830
l6	0.007 λ , 77.0 Ω	0.64 x 0.76	0.025 x 0.030
l7	0.123 λ , 72.0 Ω	11.66 x 0.89	0.459 x 0.035
l8	0.016 λ , 8.5 Ω	1.30 x 16.21	0.051 x 0.638
l9	0.096 λ , 8.5 Ω	8.13 x 16.21	0.320 x 0.638
l10	0.171 λ , 67.0 Ω	16.13 x 1.04	0.635 x 0.041
l11	0.053 λ , 41.0 Ω	4.80 x 2.31	0.189 x 0.091
l12	0.063 λ , 41.0 Ω	5.72 x 2.31	0.225 x 0.091
l13	0.030 λ , 54.0 Ω	2.79 x 1.52	0.110 x 0.060

¹Electrical characteristics are rounded.

Reference Circuit (cont.)

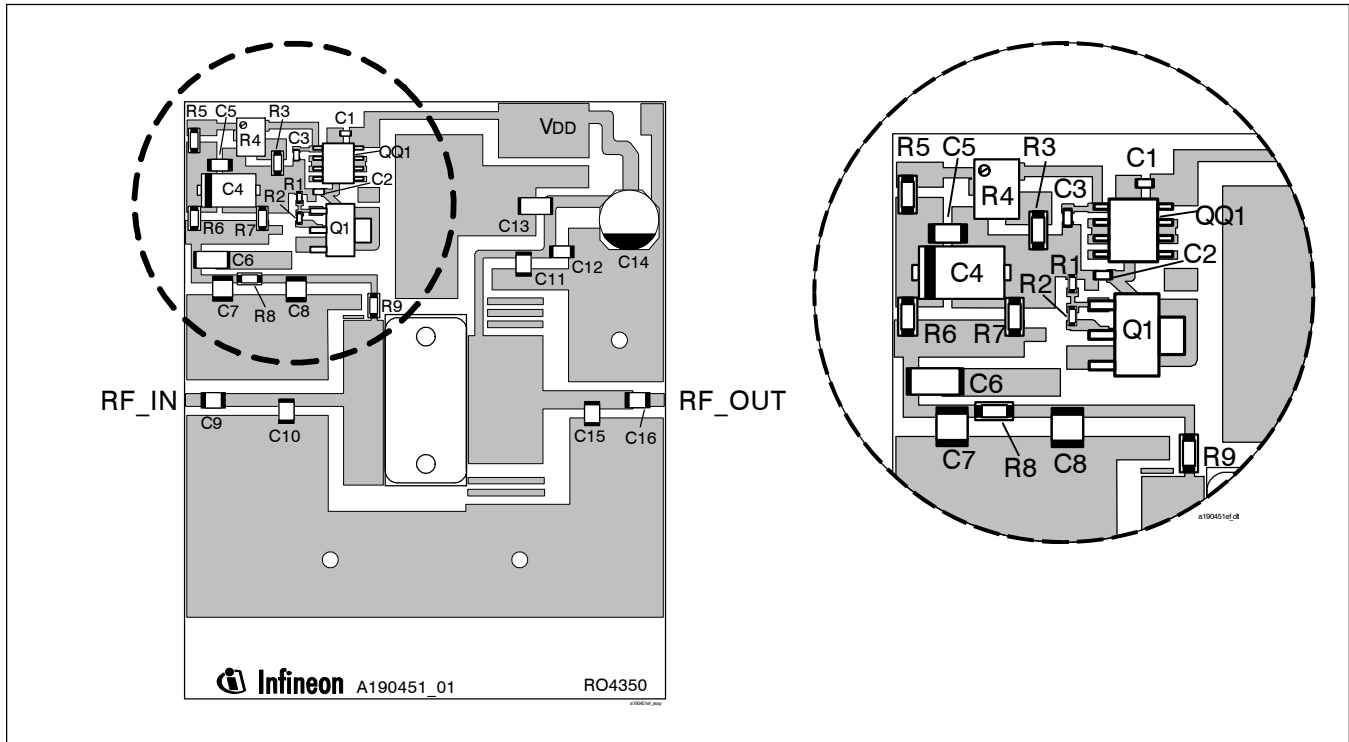

Reference circuit assembly diagram* (not to scale)

Component	Description	Suggested Manufacturer	P/N or Comment
C1, C2, C3	Capacitor, 0.001 μ F	Digi-Key	PCC1772CT-ND
C4	Tantalum capacitor, 10 μ F, 35 V	Digi-Key	399-1655-2-ND
C5	Capacitor, 0.1 μ F	Digi-Key	PCC104BCT-ND
C6, C13	Ceramic capacitor, 1 μ F	Digi-Key	445-1411-1-ND
C7	Capacitor, 0.01 μ F	ATC	200B 103
C8, C9, C11, C16	Ceramic capacitor, 10 pF	ATC	100B 100
C10	Ceramic capacitor, 2.8 pF	ATC	100B 2R8
C12	Capacitor, 0.02 μ F	ATC	200B 203
C14	Capacitor, 22 μ F, 50 V	Digi-Key	PCE3374CT-ND
C15	Ceramic capacitor, 0.7 pF	ATC	100B 0R7
Q1	Transistor	Infinion Technologies	BCP56
QQ1	Voltage regulator	National Semiconductor	LM7805
R1	Chip Resistor 1.2 k-ohms	Digi-Key	P1.2KGCT-ND
R2	Chip Resistor 1.3 k-ohms	Digi-Key	P1.3KGCT-ND
R3	Chip Resistor 2 k-ohms	Digi-Key	P2KECT-ND
R4	Potentiometer 2 k-ohms	Digi-Key	3224W-202ETR-ND
R5, R9	Chip Resistor 10 ohms	Digi-Key	P10ECT-ND
R6, R7	Chip Resistor 1 k-ohms	Digi-Key	P1KECT-ND
R8	Chip Resistor 5.1 k-ohms	Digi-Key	P5.1KECT-ND

*Gerber Files for this circuit available on request

Package Outline Specifications

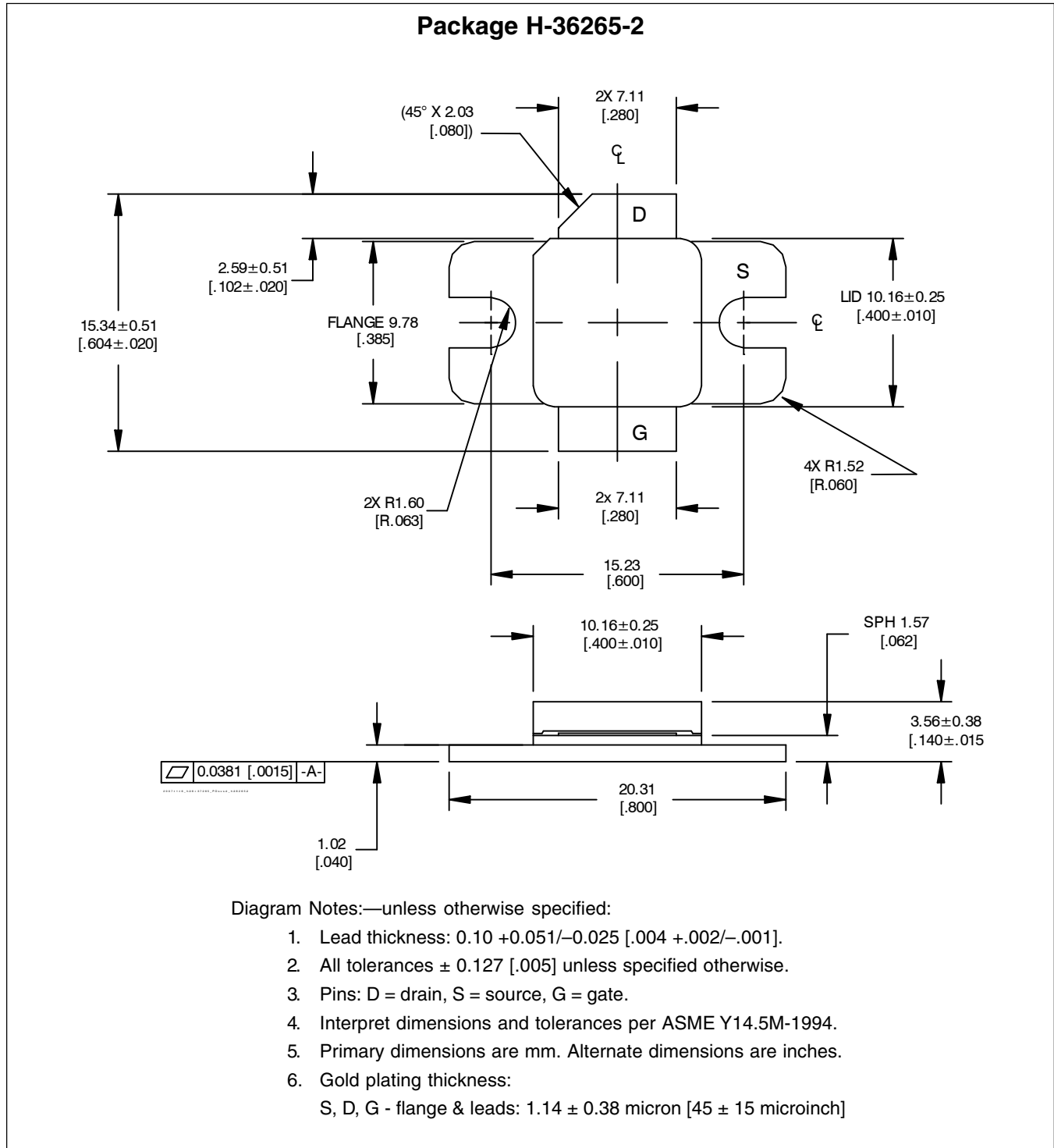

Find the latest and most complete information about products and packaging at the Infineon Internet page
<http://www.infineon.com/rfpower>

Package Outline Specifications (cont.)

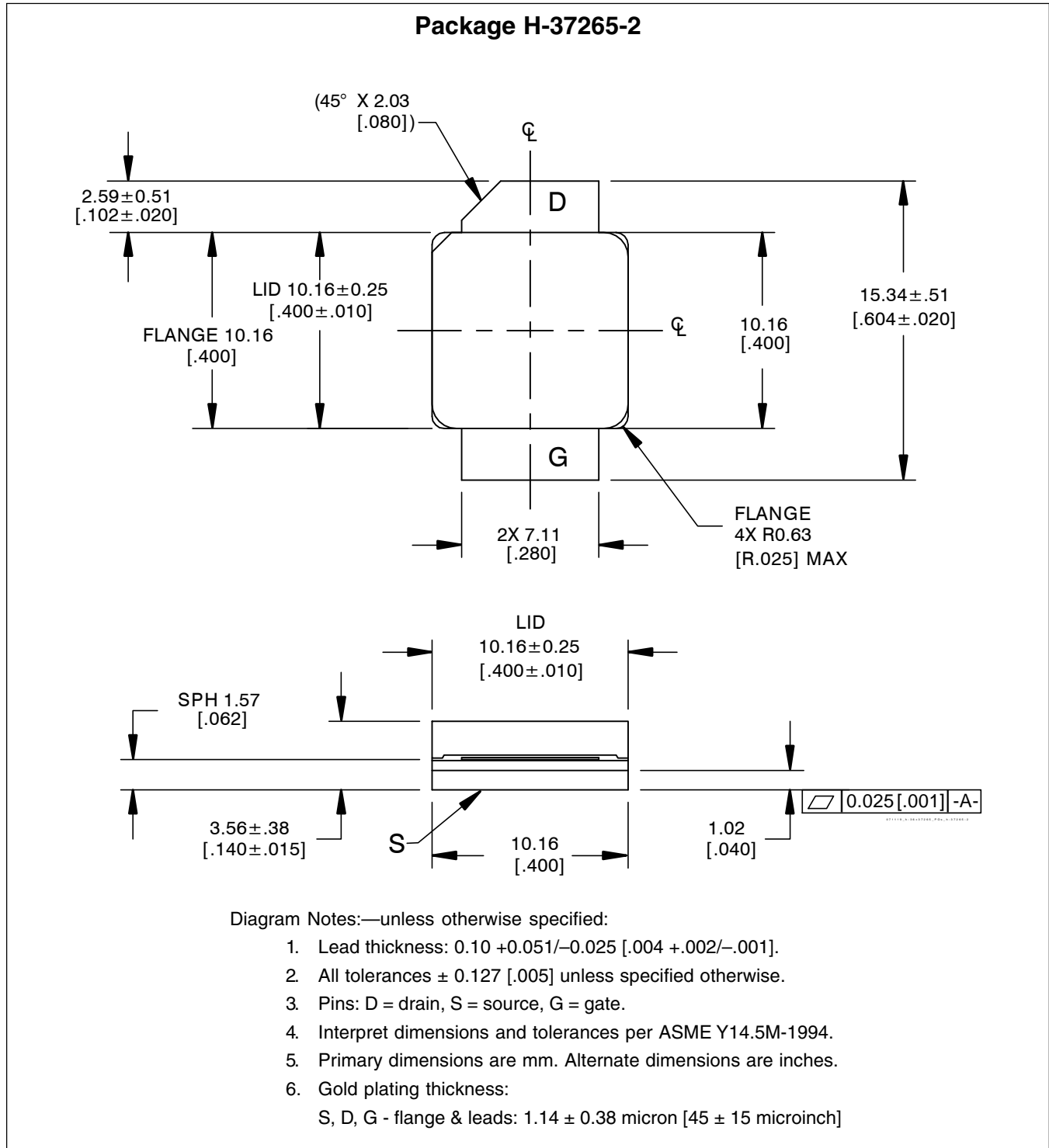

Find the latest and most complete information about products and packaging at the Infineon Internet page
<http://www.infineon.com/rfpower>

Revision History: 2008-07-16

Data Sheet

Previous Version: 2006-04-21, PTFA 190451E/F V1, Data Sheet

Page	Subjects (major changes since last revision)
1, 2, 8, 9, 10	New package and new product version.

We Listen to Your Comments

Any information within this document that you feel is wrong, unclear or missing at all?

Your feedback will help us to continuously improve the quality of this document.

Please send your proposal (including a reference to this document) to:

highpowerRF@infineon.com

To request other information, contact us at:

+1 877 465 3667 (1-877-GO-LDMOS) USA

or +1 408 776 0600 International

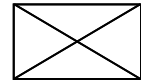

Edition 2008-07-28

Published by

Infineon Technologies AG

81726 Munich, Germany

© 2006 Infineon Technologies AG

All Rights Reserved.

Legal Disclaimer

The information given in this document shall in no event be regarded as a guarantee of conditions or characteristics. With respect to any examples or hints given herein, any typical values stated herein and/or any information regarding the application of the device, Infineon Technologies hereby disclaims any and all warranties and liabilities of any kind, including without limitation, warranties of non-infringement of intellectual property rights of any third party.

Information

For further information on technology, delivery terms and conditions and prices, please contact the nearest Infineon Technologies Office (www.infineon.com/rfpower).

Warnings

Due to technical requirements, components may contain dangerous substances. For information on the types in question, please contact the nearest Infineon Technologies Office.

Infineon Technologies components may be used in life-support devices or systems only with the express written approval of Infineon Technologies, if a failure of such components can reasonably be expected to cause the failure of that life-support device or system or to affect the safety or effectiveness of that device or system. Life support devices or systems are intended to be implanted in the human body or to support and/or maintain and sustain and/or protect human life. If they fail, it is reasonable to assume that the health of the user or other persons may be endangered.